

# 1450 lbf. Vibration System

The series of Derritron “High Performance Air Cooled” shakers are designed for a wide variety of dynamic test conditions including Sinewave, Random, Shock and Seismic simulations over a wide frequency range. We offer a complete turnkey solution for all of your testing needs by supplying complete Shaker, Amplifier and Controller packages at reasonable prices. These systems are indispensable for complete and thorough product testing.

Derritron shakers are designed to run for extended periods over a long life span. These rugged shakers offer high transverse vibration strength and high axial stiffness and can be operated in either vertical or horizontal mode. A built-in Automatic Load Support System allows the armature to remain stable even with high test loads. A high power blower insures proper cooling of the shaker and is included.



The standard Swivel Trunnion includes air isolation mounts to reduce the vibrations of the shaker from transmitting to the floor. These shakers offer a variety armature head sizes to fully accommodate your test requirements and will allow you to verify and improve the quality of your products.

## Technical Specifications:

	DVS-1450SS-7	DVS-1450-7	DVS-1450-13
Shaker	VP145SS-7	VP145-7	VP145-13
Amplifier	DSA-18-2	DSA-18-3	DSA-18-3
Rated Peak Force (lbf)    Sine/Random/Shock	1450/725/1450	1450/1450/2900	1450/1450/2900
Frequency Range (Hz)	DC-3000	DC-3000	DC-3000
Max. Displacement (In. pk-pk)	1	2	2
Max Velocity (in/s)        Sine/Random/Shock	51/51/79	67/67/98	67/67/98
Max. Acceleration (g)     Sine/Random/Shock	91/46/91	80/80/160	76/76/152
Rated Current (A)	55	90	90
Nominal Impedance (Ohm)	0.9	0.5	0.5
Suspension Stiffness (lbf/in)	371	285	285
Effective Moving Mass (lb)	15.4	17.6	18.7
Max Weight Tested (lb)	330.7	330.7	330.7
Main Resonance Frequency (Hz)	>3000	>3000	>2500
Weight With Trunnion (lb)	2205	2205	2205
Stray Magnetic Field (G)    Without/With DG Coil	85/5	85/5	85/5
Armature Size (in)	7.09	7.09	13.00
Interlocks	Temperature Overtravel Airflow	Temperature Overtravel Airflow	Temperature Overtravel Airflow



# VP145SS-7 Performance Curve

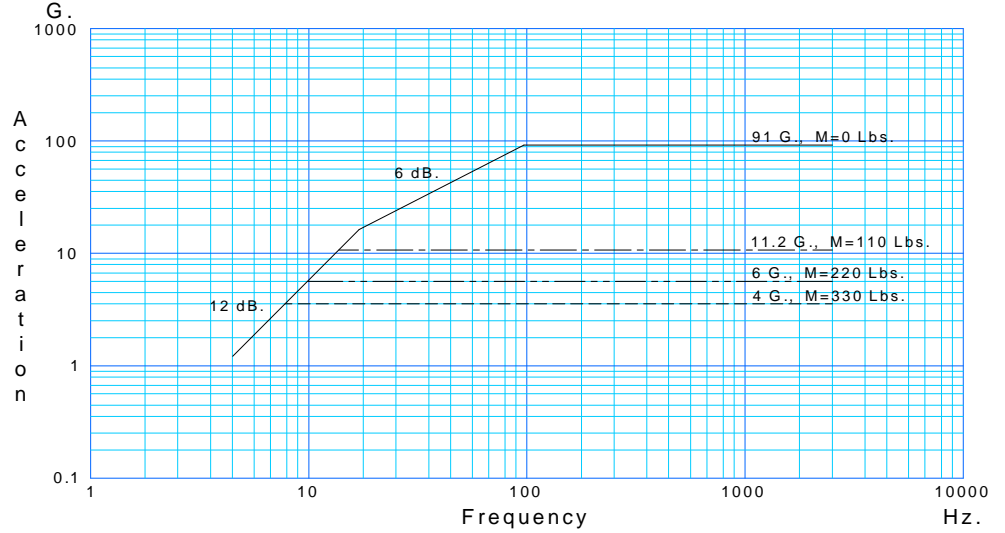

## Dimensions

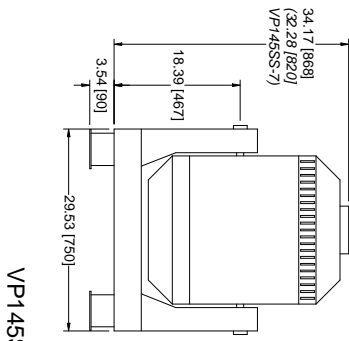

VP145SS-7 & VP145-7

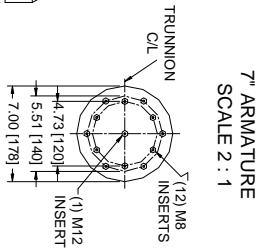
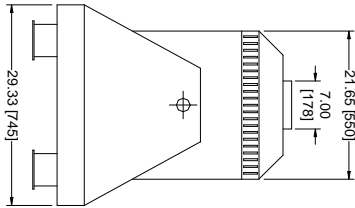

# VP145-7 Performance Curve

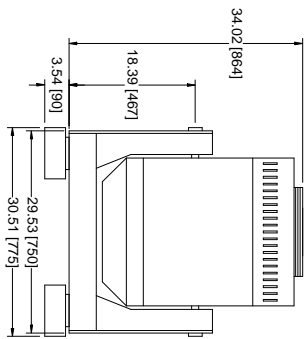
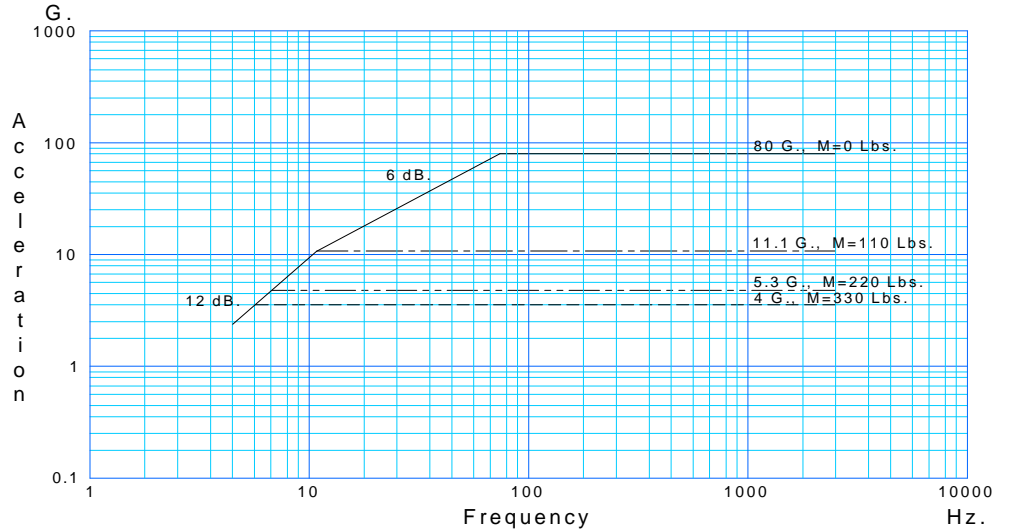

VP145-13

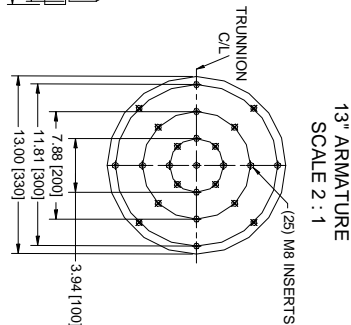
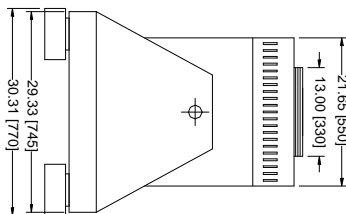

# VP145-13 Performance Curve

